

93M

Paper Folder

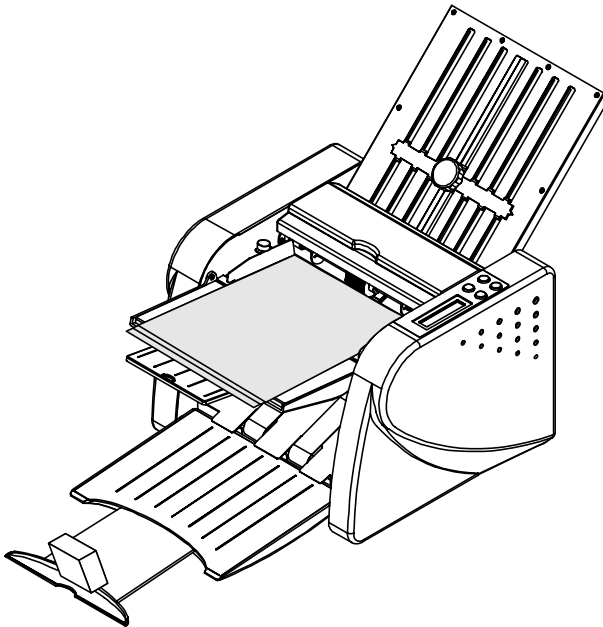



Please read these operating instructions before putting the machine into operation and observe the safety precautions.



Children must not operate the machine!



Do not touch or insert foreign objects into any rotating part during operation.



Keep long hair clear of machine!



Take care of ties and other loose pieces of clothing!



Remove any paper clips!

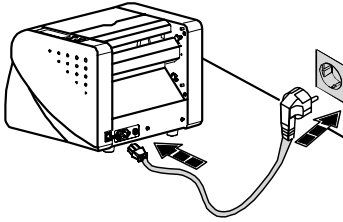

Connect the power cord to a single phase socket .
120V/4A

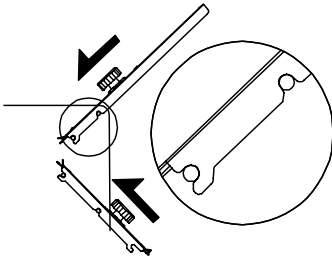

Insert the 1st fold plate(long plate) into the studs (A) and (B) and lock into position.

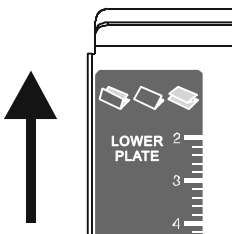

When the 2nd fold plate(short plate) put in , Please see clearly the labels at both ends as shown.

Put the label indicator: Zigzag fold, Letter fold, and Double fold into the machine. With three folding methods: Letter fold, Zigzag fold, Double fold.

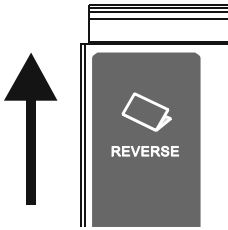

When 2nd fold plate put in ,Please see clearly the labels at both ends as shown.

Put the label indicator: only single fold into the machine as shown .Only of single fold.

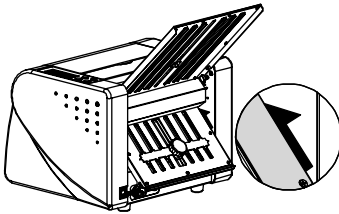

Check that the 2nd fold plate is in the correct position.

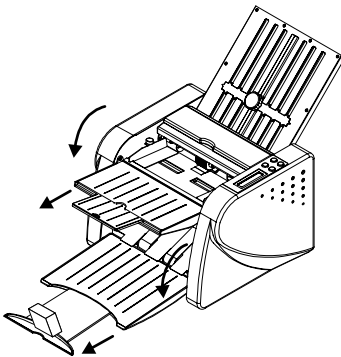

Opening the receiving paper platform, pull out the receiving paper stopper. Opening the insert paper platform, pull out the supplementary insert paper plate.

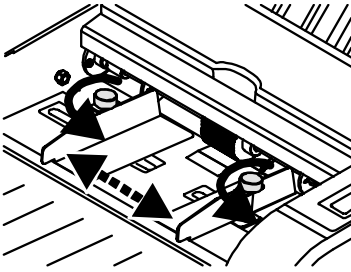

Setting the paper size and folding position.

Open the paper guides by loosening the 2 screws and push towards the sides.

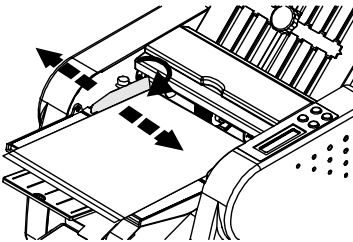

Move the paper guides to the edge of the paper. Tighten the screws.

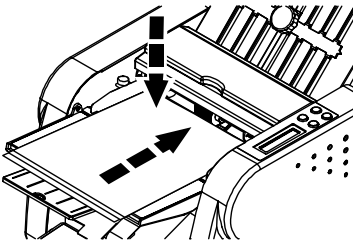

Press down the paper guide and insert paper as far as possible.

Paper Ready:

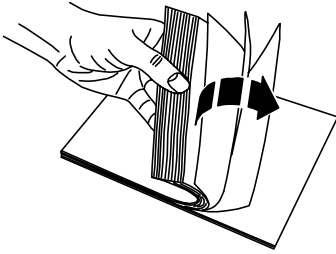

Fan the paper stack.

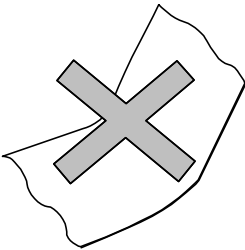

Do not fold curly paper.

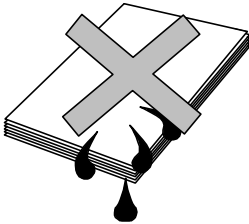

Do not fold wet paper.

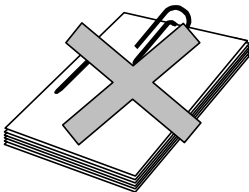





Do not fold paper with clips or staples.

Installation

This machine has four folding patterns,(LT、LG).

Classified as:

1. Letter fold 
2. Zigzag fold 
3. Double Fold 
4. Single Fold 

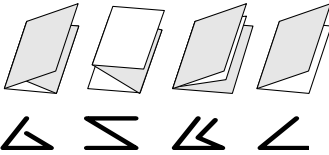

Adjust stopper plate on the 1st fold plate:    

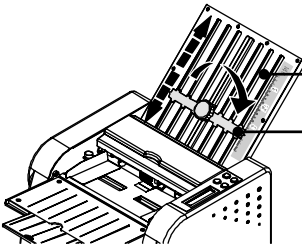

1st fold plate

stopper plate

Check that the paper has been folded correctly and if necessary adjust the stopper plate on the 1st fold plate and/or 2nd fold plate. As soon as the 1st fold plate is correct, adjust the 2nd fold.

Adjust stopper plate on the 2nd fold plate:   

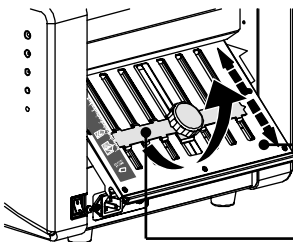

2nd fold plate

stopper plate

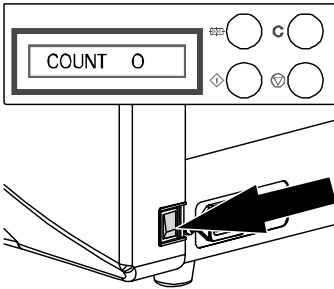

Switch on the main switch.

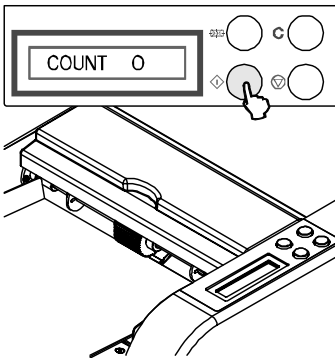

Press the START key paper will be folded.

Examples of folds on page 15~17

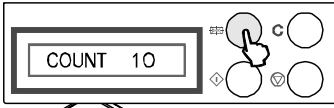

If number of folding paper setting is required, press increase button. Press once, each for 10 sheets up.

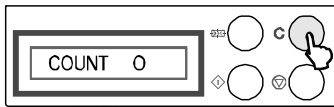
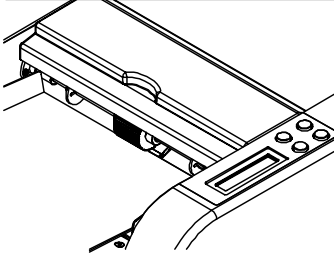

Counter returns to "0" when pressing the "C" button.

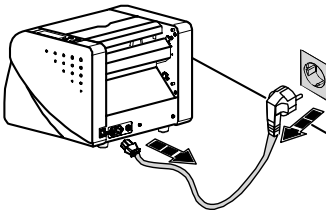
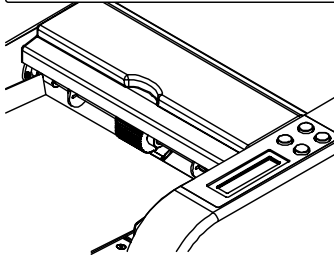

Disconnect from the main socket if not used for a longer period.

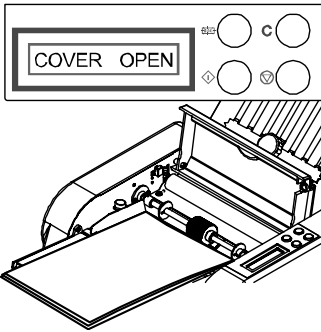

The machine cover must be closed.

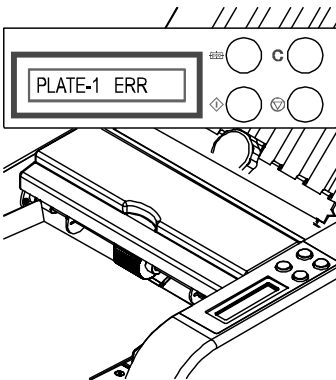

Mount the 1st fold plate according to instruction. See "Installation".

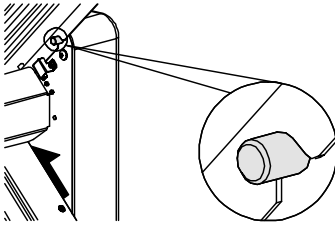

Fix the fold plate tightly (the hook of the fold plate click on the supportive).

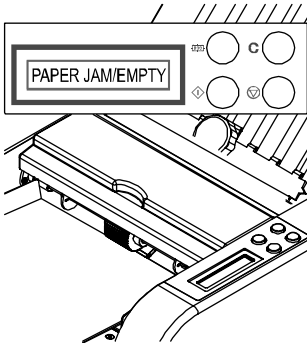

Clear the Jammed paper/refill the paper feeder.

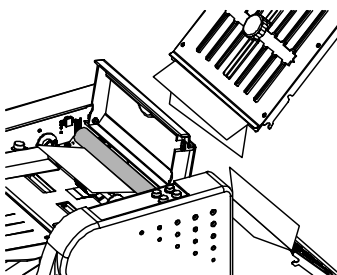

Remove both fold plates and any paper debris.

Open the roller cover. Remove paper debris from the machine. Making sure no debris is left in the paper guides.

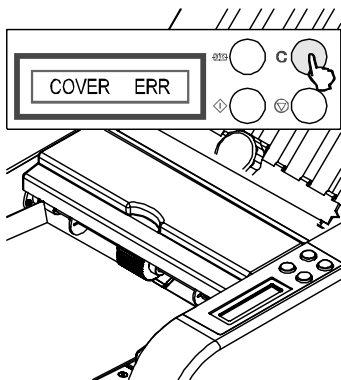

Press the “C” button to clear up the malfunctions.

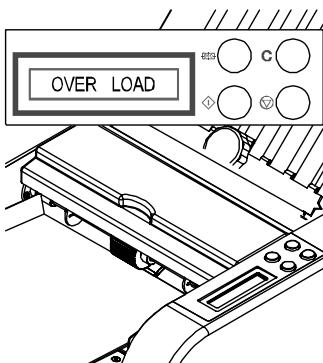

Switch off the machine and wait 1min before switching on again.

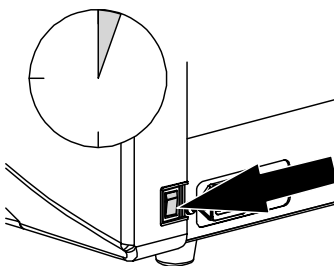

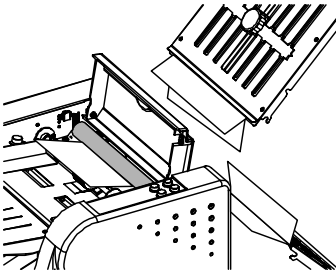

Remove both fold plates and any paper debris.

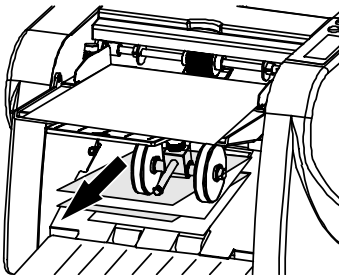

Clear the jammed paper.

Adjustment

Letter Fold	Adjust stopper plate position	
	Deviations of stopper plate from label indicator	
	A. too long	A. too short
	B. too long	B. too short
	A、 B、 C not up to standard	
	<p>1.First adjust A side to standard, use label indicator as basic benchmark. According to paper thickness, slightly move the stopper plate on the 1st fold plate. Adjust A side as 1/3 of the paper length.</p> <p>2.Then adjust B side, use label indicator as benchmark, relative to paper thickness slightly move the stopper plate on the 2nd fold plate, adjust to standard.</p>	

Adjustment

Zigzag Fold	Adjust stopper plate position	
	Deviations of stopper plate from label indicator	
	A. too long	A. too short
	B. too long	B. too short
	A、 B、 C not up to standard	
	<p>1.First adjust C side to standard, use label indicator as basic benchmark. According to paper thickness, slightly move the stopper plate on the 1st fold plate. Adjust C side as 1/3 of the paper length.</p> <p>2.Then adjust A side, use label indicator as benchmark, relative to paper thickness slightly move the stopper plate on the 2nd fold plate, adjust to standard.</p>	

Adjustment

Single Fold	Adjust stopper plate position	
	Deviations of stopper plate from label indicator	
	A. too long	A. too short
Double Fold	A. too long	A. too short
	B. too long	B. too short
	A、 B、 C not up to standard	
	<p>1.First adjust the 1st fold plate according to single opposite folding method, adjust to 1/2 of the paper length.</p> <p>2.Then adjust the 2nd fold plate, use label indicator as benchmark, relative to paper thickness slightly move the stopper plate, adjust to standard.</p>	

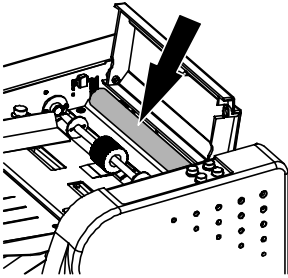

Wipe the rubber folding roller,

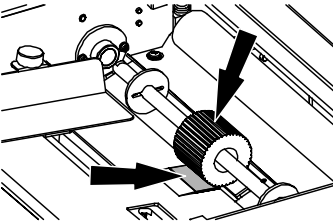

Wipe the surface on the feeding rollers
with MBM roller cleaner.

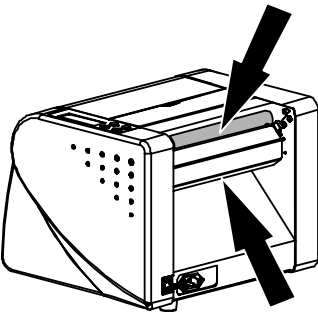

Wipe the rubber folding roller.

Paper roller and separator, belongs to replaceable consumables.

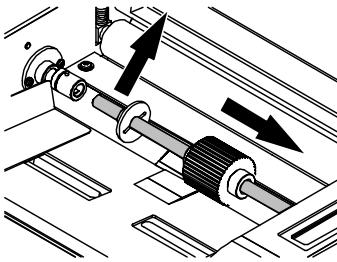

Remove the paper feed roller.

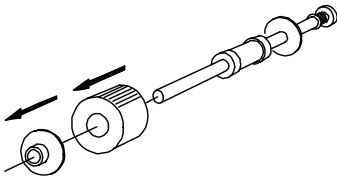

Remove the folding roller.

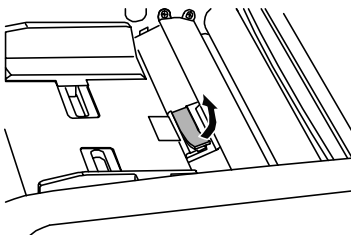

Remove the separator with a sharp edged tool and replace them.
